

DENON

TUNER-5CD CHANGER

DN-H800

OPERATING INSTRUCTIONS

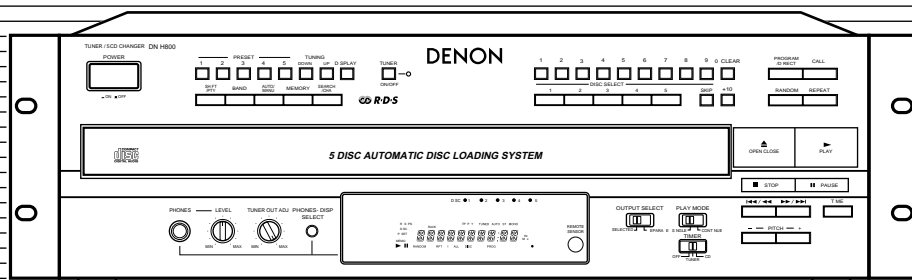

FOR ENGLISH READERS

PAGE 7 ~ PAGE 24

"SERIAL NO. _____
PLEASE RECORD UNIT SERIAL NUMBER ATTACHED TO THE REAR OF THE
CABINET FOR FUTURE REFERENCE"

IMPORTANT TO SAFETY

WARNING:

TO PREVENT FIRE OR SHOCK HAZARD, DO NOT EXPOSE THIS APPLIANCE TO RAIN OR MOISTURE.

CAUTION:

1. Handle the power supply cord carefully

Do not damage or deform the power supply cord. If it is damaged or deformed, it may cause electric shock or malfunction when used. When removing from wall outlet, be sure to remove by holding the plug attachment and not by pulling the cord.

2. Do not open the top cover

In order to prevent electric shock, do not open the top cover. If problems occur, contact your DENON dealer.

3. Do not place anything inside

Do not place metal objects or spill liquid inside the TUNER-5CD CHANGER.

Electric shock or malfunction may result.



CAUTION: TO REDUCE THE RISK OF ELECTRIC SHOCK, DO NOT REMOVE COVER (OR BACK). NO USER-SERVICEABLE PARTS INSIDE. REFER SERVICING TO QUALIFIED SERVICE PERSONNEL.



The lightning flash with arrowhead symbol, within an equilateral triangle, is intended to alert the user to the presence of uninsulated "dangerous voltage" within the product's enclosure that may be of sufficient magnitude to constitute a risk of electric shock to persons.



The exclamation point within an equilateral triangle is intended to alert the user to the presence of important operating and maintenance (servicing) instructions in the literature accompanying the appliance.

CAUTION: USE OF CONTROLS OR ADJUSTMENTS OR REFORMANCE OF PROCEDURES OTHER THAN THOSE SPECIFIED HEREIN MAY RESULT IN HAZARDOUS RADIATION EXPOSURE.

THE COMPACT DISC PLAYER SHOULD NOT BE ADJUSTED OR REPAIRED BY ANYONE EXCEPT PROPERLY QUALIFIED SERVICE PERSONNEL.

This device complies with Part 15 of the FCC Rules. Operation is subject to the following two conditions : (1) This device may not cause harmful interference, and (2) this device must accept any interference received, including interference that may cause undesired operation.

This Class B digital apparatus meets all requirements of the Canadian Interference-Causing Equipment Regulations.

Cet appareil numérique de la classe B respecte toutes les exigences du Règlement sur le matériel brouilleur du Canada.

• FOR U.S.A. & CANADA MODEL ONLY

CAUTION

TO PREVENT ELECTRIC SHOCK DO NOT USE THIS (POLARIZED) PLUG WITH AN EXTENSION CORD, RECEPTACLE OR OTHER OUTLET UNLESS THE BLADES CAN BE FULLY INSERTED TO PREVENT BLADE EXPOSURE.

• POUR LES MODELES AMERICAINS ET CANADIENS UNIQUEMENT

ATTENTION

POUR PREVENIR LES CHOCS ELECTRIQUES NE PAS UTILISER CETTE FICHE POLARISEE AVEC UN PROLONGATEUR UNE PRISE DE COURANT OU UNE AUTRE SORTIE DE COURANT, SAUF SI LES LAMES PEUVENT ETRE INSEREES A FOND SANS EN LAISSER AUCUNE PARTIE A DECOUVERT.



- Use compact discs that include the  mark. CD's with special shapes (heart-shaped CD's, octagonal CD's etc.) cannot be played on this set. Attempting to do so may damage the set. Do not use such CD's.

- Utiliser des disques compacts portant le logo . Des CD avec des formes spéciales (CD en forme de coeur, des CD octogonaux, etc.) ne peuvent pas être lus sur cet appareil. Le fait de l'essayer, risque d'endommager le lecteur. Ne pas utiliser de tels CD.

- Use discos compactos con la marca . En este equipo no es posible reproducir CDs con formas especiales (CDs con forma de corazón, CDs octogonales, etc.). Si intenta hacerlo, el equipo podrá resultar dañado. No use este tipo de CDs.

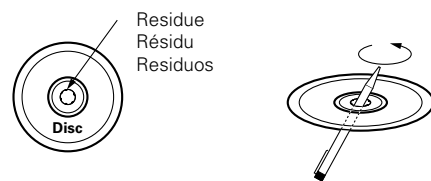

- The disc may not play normally if there is residue along the edges of the center hole.
- When using new discs in particular, use a pen, etc., to remove the residue.
- Le disque peut ne pas être lu normalements s'il y a un résidu le long des bord du trou central.
- Lors de l'utilisation de nouveaux disques en particulier, utiliser un stylo à bille, etc., pour enlever le résidu.
- El disco no puede ser reproducido normalmente debido a la terminación deficiente de los bordes del agujero central.
- Para quitar estos residuos de material, especialmente cuando vaya a re-reproducir discos nuevos, utilice un bolígrafo, o algo similar.

SAFETY INSTRUCTIONS



1. Read Instructions – All the safety and operating instructions should be read before the appliance is operated.
2. Retain Instructions – The safety and operating instructions should be retained for future reference.
3. Heed Warning – All warnings on the appliance and in the operating instructions should be adhered to.
4. Following Instructions – All operating and use instructions should be followed.
5. Water and Moisture – The appliance should not be used near water – for example, near a bathtub, washbowl, kitchen sink, laundry tub, in a wet basement, or near a swimming pool, and the like.
6. Carts and Stands – The appliance should be used only with a cart or stand that is recommended by the manufacturer.
- 6A. An appliance and cart combination should be moved with care. Quick stops, excessive force, and uneven surfaces may cause the appliance and cart combination to overturn.
7. Wall or Ceiling Mounting – The appliance should be mounted to a wall or ceiling only as recommended by the manufacturer.
8. Ventilation – The appliance should be situated so that its location or position does not interfere with its proper ventilation. For example, the appliance should not be situated on a bed, sofa, rug, or similar surface that may block the ventilation openings; or, placed in a built-in installation, such as a bookcase or cabinet that may impede the flow of air through the ventilation openings.
9. Heat – The appliance should be situated away from heat sources such as radiators, heat registers, stoves, or other appliances (including amplifiers) that produce heat.
10. Power Sources – The appliance should be connected to a power supply only of the type described in the operating instructions or as marked on the appliance.
11. Grounding or Polarization – Precautions should be taken so that the grounding or polarization means of an appliance is not defeated.

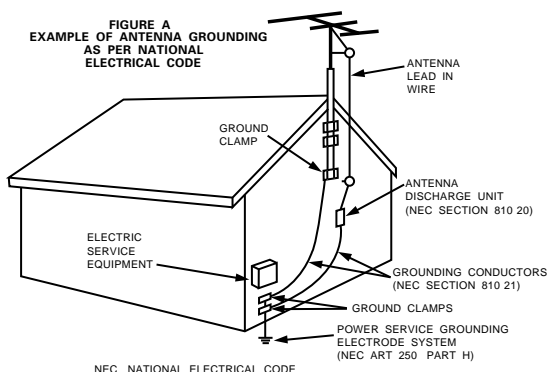

12. Power-Cord Protection – Power-supply cords should be routed so that they are not likely to be walked on or pinched by items placed upon or against them, paying particular attention to cords at plugs, convenience receptacles, and the point where they exit from the appliance.
14. Cleaning – The appliance should be cleaned only as recommended by the manufacturer.
15. Power Lines – An outdoor antenna should be located away from power lines.
16. Outdoor Antenna Grounding – If an outside antenna is connected to the receiver, be sure the antenna system is grounded so as to provide some protection against voltage surges and built-up static charges. Article 810 of the National Electrical Code, ANSI/NFPA 70, provides information with regard to proper grounding of the mast and supporting structure, grounding of the lead-in wire to an antenna-discharge unit, size of grounding conductors, location of antenna-discharge unit, connection to grounding electrodes, and requirements for the grounding electrode. See Figure A.
17. Nonuse Periods – The power cord of the appliance should be unplugged from the outlet when left unused for a long period of time.
18. Object and Liquid Entry – Care should be taken so that objects do not fall and liquids are not spilled into the enclosure through openings.
19. Damage Requiring Service – The appliance should be serviced by qualified service personnel when:
 - A. The power-supply cord or the plug has been damaged; or
 - B. Objects have fallen, or liquid has been spilled into the appliance; or
 - C. The appliance has been exposed to rain; or
 - D. The appliance does not appear to operate normally or exhibits a marked change in performance; or
 - E. The appliance has been dropped, or the enclosure damaged.
20. Servicing – The user should not attempt to service the appliance beyond that described in the operating instructions. All other servicing should be referred to qualified service personnel.

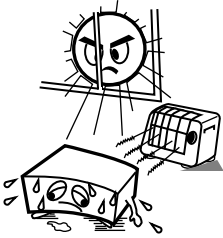
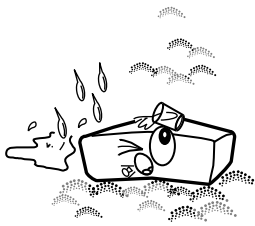
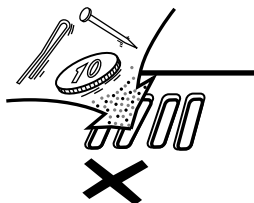
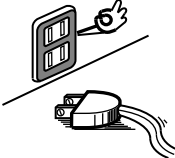

NOTE ON USE / OBSERVATIONS RELATIVES A L'UTILISATION

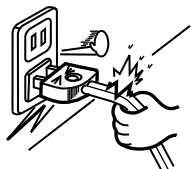
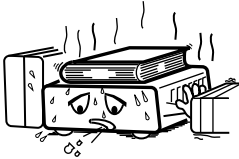
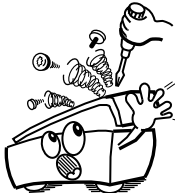
 <ul style="list-style-type: none"> • Avoid high temperatures. Allow for sufficient heat dispersion when installed on a rack. • Eviter des températures élevées. Tenir compte d'une dispersion de chaleur suffisante lors de l'installation sur une étagère. • Evite altas temperaturas. Permite la suficiente dispersión del calor cuando está instalado en la consola. 	 <ul style="list-style-type: none"> • Keep the set free from moisture, water, and dust. • Protéger l'appareil contre l'humidité, l'eau et lapoussière. • Mantenga el equipo libre de humedad, agua y polvo. 	 <ul style="list-style-type: none"> • Do not let foreign objects in the set. • Ne pas laisser des objets étrangers dans l'appareil. • No deje objetos extraños dentro del equipo.
	 <ul style="list-style-type: none"> • Unplug the power cord when not using the set for long periods of time. • Débrancher le cordon d'alimentation lorsque l'appareil n'est pas utilisé pendant de longues périodes. • Desconecte el cordón de energía cuando no utilice el equipo por mucho tiempo. 	 <ul style="list-style-type: none"> • Do not let insecticides, benzene, and thinner come in contact with the set. • Ne pas mettre en contact des insecticides, du benzène et un diluant avec l'appareil. • No permita el contacto de insecticidas, gasolina y diluyentes con el equipo.
 <ul style="list-style-type: none"> • Handle the power cord carefully. Hold the plug when unplugging the cord. • Manipuler le cordon d'alimentation avec précaution. Tenir la prise lors du débranchement du cordon. • Maneje el cordón de energía con cuidado. Sostenga el enchufe cuando desconecte el cordón de energía. 	 <p>* (For sets with ventilation holes)</p> <ul style="list-style-type: none"> • Do not obstruct the ventilation holes. • Ne pas obstruer les trous d'aération. • No obstruya los orificios de ventilación. 	 <ul style="list-style-type: none"> • Never disassemble or modify the set in any way. • Ne jamais démonter ou modifier l'appareil d'une manière ou d'une autre. • Nunca desarme o modifique el equipo de ninguna manera.

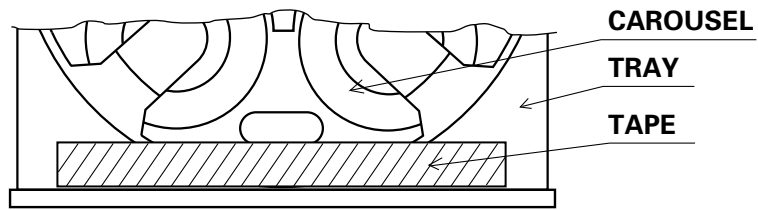
**CAUTION**

1. When the unit is to be transported, apply tape as illustrated in the diagram so that the carousel inside the tray does not turn.
2. Always remove all discs from the trays when moving the set. Failure to do so may damage the set.
3. When the power is turned off, the varied level will be cleared and be set to 0 dB.

ATTENTION

1. Lorsque l'appareil doit être transporté, placer le couvercle comme illustré sur le schéma, de façon à ce que le carrousel à l'intérieur du plateau ne tourne pas.
2. Toujours retirer les disques du plateau avant toute manipulation. En cas contraire l'appareil pourrait être endommagé.
3. Lorsque le lecteur est éteint, le niveau varié est effacé et remis à 0 dB.

Thank you for purchasing the DENON TUNER-5CD CHANGER. Read the Operating Instructions thoroughly, and operate this player properly.

— TABLE OF CONTENTS —

FEATURES6
 CAUTIONS DURING USE6
 NAMES OF PARTS AND THEIR FUNCTIONS7 ~ 10
 OPENING AND CLOSING THE DRAWER AND LOADING A DISC11
 CONNECTIONS13, 14
 NORMAL PLAY14
 OTHER PLAY METHODS14 ~ 18
 INSTALLATION PRECAUTIONS18
 COMPACT DISCS18
 LISTENING TO RADIO PROGRAMS19 ~ 21
 USING THE TIMER21
 REMOTE CONTROL UNIT21
 TROUBLESHOOTING22
 SPECIFICATIONS23

Please check to make sure the following items are included with the main unit in the carton:

- (1) Operating instructions1
- (2) Connection Cords1
- (3) AM LOOP Antenna1
- (4) Service Station List1

NOTE:

This TUNER-5CD CHANGER uses the semiconductor laser. To allow you to enjoy music at a stable operation, it is recommended to use this in a room of 10 °C (50 °F) ~ 35 °C (95 °F).

CAUTIONS DURING USE

- This TUNER-5CD CHANGER is capable of playing discs which have the mark at right.
- During track selection, during search and when the player sustains a strong impact, the disc's rotational speed changes greatly, causing a small noise to be emitted. This is not a malfunction of the player.
- The DN-H800 has a broad dynamic range. Please exercise caution when turning up the volume on the amplifier in cases when the playback volume is low. If the volume is turned up too high, it could damage the speakers.



CAUTION:

- The DN-H800 will work normally when the player unit is mounted with the front panel within 15 degrees of the vertical plane. If the unit is tilted excessively, discs may not load or unload properly.

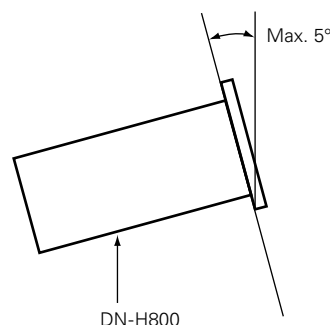

FEATURES

5CD CHANGER

- Carousel-type changer mechanism included
 This mechanism can house five discs, and while one disc is playing the remaining four discs can be changed. In addition, the carousel can be rotated either clockwise or counterclockwise, so searching between discs is fast.
- 20-track programming and random play
- ±12 % variable pitch playback
- Single/continuous playback function

TUNER

- RDS programs can be easily received (FM only)
- AM/FM 30-station random preset tuner

GENERAL

- 19-inch rack mountable
- Headphone monitor and display switchable
 The headphone monitor and display can be switched from CD to TUNER and TUNER to CD.
- Wired remote control capability
- Headphones jack with volume control

- Do not use any discs but exclusive audio discs with this TUNER-5CD CHANGER.
- Placing this player or its connection cords near a TV or other audio device could cause a humming sound to be emitted. If this occurs, relocate the player or reroute the connection cords.
- Be sure to remove the disc from the player before moving it. The discs could be damaged if left in the player while it is being moved.
- Do not place any object in the position where the disc is loaded, or open and close the tray with anything inside. Foreign objects in the tray could damage the play mechanism.
- Do not move the player from a cold place to a warm place suddenly. If the player is cold when brought into a warm room, condensation could form, preventing proper operation of the player. If condensation does form on the player when it is brought into a warm room, wait at least 30 minutes before use.

NAMES OF PARTS AND THEIR FUNCTIONS (Refer to page 4.)

FRONT PANEL

- 1 POWER switch**
 - Press this button to switch on the power.
- 2 Loading drawer**
 - Discs can be loaded and unloaded when this drawer is open.
Do not force the drawer closed by hand.
- 3 Preset channel button (1 to 5)**
 - Use these when presetting and recalling stations. Also use these with the SHIFT/PTY button to use a total of 30 preset channels, A (1 to 5), B (1 to 5), ... F (1 to 5).
- 4 SHIFT/PTY button**
 - Use this button to select the memory blocks, A (1 to 5), B (1 to 5), C (1 to 5), D (1 to 5), E (1 to 5), or F (1 to 5).
 - For PTY search use this button to select the program type. When writing station names, use this button to set the writing position.
- 5 BAND button**
 - Selects FM or MW (AM).
- 6 Tuning mode button (AUTO/MANU)**
 - This switches between auto and manual tuning.
Auto tuning: (The "AUTO" indicator lights.)
When TUNING UP and DOWN buttons is pressed in this mode, auto tuning starts and tuning stops automatically when a broadcast station is found. Auto tuning is used to receive FM broadcasts in stereo. Depending on the mode of the broadcast and the strength of the signal, auto tuning will automatically switch the receiving mode to stereo or monaural. During tuning, the frequency is automatically tuned up or down.
Manual tuning:
When TUNING UP and DOWN buttons is pressed in this mode, manual tuning is performed until the control is released. The broadcast is received in monaural regardless of the mode of the FM broadcast. The reception mode should be set to manual when there is noisy reception of stereo broadcasts (which are indicated by the lighting of "AUTO") and also when the signal is weak. During tuning, the reception frequency is tuned up or down only when the tuning buttons is operated.
- 7 MEMORY button**
 - Frequencies and station names can be stored in the memory. When this button is pressed, the "MEMO" indicator on the display flashes for 10 seconds. Use the SHIFT/PTY button and the preset channel buttons during this time to designate the desired preset channel.
- 8 TUNING UP and DOWN buttons**
 - These buttons are used to select AM and FM stations.
- 9 Display mode selector button (DISPLAY)**
 - This button is used to select the display mode.
- The mode changes as follows each time the button is pressed:
Tuning frequency
Input character
Programme service name (PS)
Programme type (PTY)
Clock Time (CT)
- The following may be displayed if the signals are weak or no RDS service is available. This is not a malfunction.
"NO PS"
"NO PTY"
"NO CT"
NOTE:
The programme type, programme service name and clock time are not displayed in the MW (AM) band.
"NO CT" may be displayed within the first minute after a station is tuned in, but this is not a malfunction. If time data is being broadcast, the time can be displayed after one minute has passed.
- 10 Search/Character mode button (SEARCH/CHA)**
 - This button is used for the RDS search (Refer to page 20, 21), PTY search (Refer to page 21) and TP search (Refer to page 21) operations, and to input the station name (Refer to page 20).
- 11 TUNER ON/OFF button**
 - This button turns the tuner output on and off.
 - When off, the sound of the tuner is not output from any output. If any tuner-related button is pressed when the tuner is turned off, the tuner turns on and the indicator lights.
- 12 DISC SELECT button (1 to 5)**
 - Press this button to select the disc number.
- 13 Number buttons (1, 2, 3, 4, 5, 6, 7, 8, 9, 0/CLEAR and +10)**
 - Use these buttons for the direct search and program memory functions. For direct search, press for example button **3** if you want to hear track number 3. For track number 12, press **+10** then **2**. For track number 33, press **+10** three times, then press **3**. To program tracks, press the PROGRAM/DIRECT button **17** to set to the program mode.
- 14 SKIP button**
 - Each time this button is pressed, the carousel will rotate in a clockwise direction to the next tray position. This allows for loading or unloading of discs.
This button is also used to select the next disc, in the normal play continuously.
- 15 OPEN/CLOSE button (▲)**
 - Press this button when opening.
 - The drawer is opened toward the front.
 - Press the button again to close the drawer.

16 RANDOM button

- Press this button to begin random play.
- Pressing this button during stop, and press play button play to full automatic random play.
- Pressing this button during playing of a program starts random play of the tracks in the program.
(Refer to page 17, item 7.)

17 PROGRAM/DIRECT button

- Press this button when you want you enter tracks for programmed playback. (Refer to page 16.)

18 CALL button

- When this button is pressed in the program mode, the programmed track numbers are called out.
- When the 0/CLEAR button 13 is pressed, the displayed track number is cleared. (Refer to page 16.)

19 REPEAT button

- Press this button for repeated playback. The "RPT" indicator appears on the display. The following three types of repeat modes are available:
- When pressed once, the "RPT" and "1" indicators light and the track currently playing is repeated.
- When pressed again, the "RPT" and "DISC" indicators light and all the tracks on the disc currently playing are repeated.
- When pressed again, the "RPT" and "ALL DISC" indicators light and all the discs currently set on the tray are repeated.
- When pressed again, the "RPT" and "ALL DISC" indicators turn off and the repeat mode is cancelled.
The repeat function can also be used during programmed and random playback, but in this case only the all repeat ("ALL DISC" indicator) modes are available.
(Refer to page 17, 6.)

20 PLAY button (▶)

- Press this button to play a disc.
The "▶" indicator lights up when the button is pressed, the number of the disc and the track being played is displayed by the Disc Number and Track No. indicator, and the amount of elapsed time for the current track is displayed by the Time indicator.
- The "▶" indicator goes off after playing of the final track of the final disc is finished and the player stops.

21 PAUSE button (||)

- Press this button to stop play temporarily.
- Pressing the Pause button during play stops play temporarily. The "▶" indicator goes off and the "||" indicator lights up.
- To cancel the Pause state, press either the PLAY button 20 or press the PAUSE button 21 a second time.

22 TIME button

- Press this button during the play or pause mode to switch the time display.

Normally the elapsed time for the track currently playing is displayed. When this button is pressed, the display switches to the

remaining time for the track



total remaining time on the disc



then back to the elapsed time per track

During programmed playback, the total remaining time display indicates the total remaining time of the programmed tracks.

23 Automatic/Manual search forward button (▶▶/▶▶I)

- Press this button to move the pickup forward to the beginning of the next track. Press again to move ahead to other tracks.
- By pressing the button a number of times, the pickup will advance the corresponding number of tracks.
- Keep on pressing this button for more than 0.5 seconds during playback for fast forward search. As long as the button is kept pressed, music signals are played back faster than normal.
- Keep on pressing this button for more than 0.5 seconds when the pause mode is engaged, you can quickly forward the pickup to a desired position, three times faster compared to manual forward search during playback. During this time, no sound is heard.

24 PITCH – and + buttons

- Press these buttons to set the playing pitch within a range of +12% to –12%.
- The set playing pitch is shown on the display.

25 Automatic/Manual search reverse button (I◀◀/◀◀I)

- Press this button to return the pickup to the beginning of the present track. Press again to return to other tracks.
- By pressing the button a number of times, the pickup will move back the corresponding number of tracks.
- Keep on pressing this button for more than 0.5 seconds during playback for fast reverse search. As long as the button is kept pressed, music signals are played back faster than normal.
- Keep on pressing this button for more than 0.5 seconds when the pause mode is engaged, you can quickly reverse the pickup to a desired position, three times faster compared to manual reverse search during playback. During this time, no sound is heard.

26 STOP button (■)

- Press this button to stop play.

27 TIMER switch

- Slide this switch when setting the timer and to turn the timer on so that it operates at the set times. (Refer to page 22.)

28 PLAY MODE switch

- Use this to select the play mode.
- The play mode switch functions in the normal play, program play and random play modes.

SINGLE: (single track play mode)

The stop mode is set after one track is played.

CONTINUE: (continuous play mode)

Playback continues on to the next track after one track is played.

NOTES:

- Repeat playback is not possible in the single mode.
- If the random play or programmed play mode is set in the single mode, random or programmed playback stops after one track.

29 OUTPUT SELECT switch

- This switches the output from the SELECTED/TUNER output terminal as follows:

SELECTED:

The sound of the tuner is output when the tuner is operated, the sound of the CD is output when the CD player is operated. When switched from the CD to the tuner, CD playback stops.

SEPARATE:

The sound of the tuner is always output, regardless of what is shown on the display or what is operated. In this mode, CD playback does not stop when the tuner is operated.

30 Remote Control Sensor (REMOTE SENSOR)

- This sensor receives the infrared light transmitted from the wireless remote control unit.
- This product does not come with a remote control unit.

31 Disc indicators (1 to 5)

- These indicate whether discs are loaded.
- All the indicators light green when the loading drawer is opened. When the loading drawer is closed, the tray spins, and if the set detects that no disc is loaded, the indicator for that disc number turns off.

32 Display

- Refer to page 11.

33 Headphones/display select button (PHONES-DISP SELECT)

- This button switches between the headphones output and the display.
- When the OUTPUT SELECT switch is set to the SEPARATE position, the headphones output and display switch to the CD when in the tuner mode, to the tuner when in the CD mode. When the OUTPUT SELECT switch is set to the SELECTED position the headphones output and display cannot be switched.

34 Tuner output adjustment control (TUNER OUT ADJ)

- Use this to adjust the level of the tuner output from the SELECTED/TUNER and headphones output jacks.
- Even if the OUTPUT SELECT switch is set to the SELECTED position, this control only adjusts the tuner's output level. It does not change the CD's output level.

35 PHONES LEVEL control

- Use this to adjust the output level of the headphones.

36 Headphones jack (PHONES)

- For private listening, you can connect your headphones to this jack. Do not raise the volume level too much when listening through headphones.

37 Disc trays (1 to 5)

- One disc per tray can be loaded.

NOTE:

Do not stop the carousel by hand when it is turning. If this is done, the microprocessor erroneously determines the disc number and the disc can be damaged.

REAR PANEL**38 AM antenna terminals (ANTENNA TERMINAL AM/GND)**

- Connect the included AM loop antenna. (Refer to page 13 for connections.)
Connect with this terminal when a medium wave outdoor antenna is used.

39 FM antenna terminals (ANTENNA TERMINAL FM)

- 75 Ω /ohm coaxial cables can be connected to these terminals. For the connection procedure, see the section "CONNECTIONS". (Refer to page 13.)

40 BALANCED OUT (CD) connectors

- These are active balanced outputs using XLR type connectors. The CD's playback signals are output from these connectors.
- Pin layout: 1. Common
2. Cold
3. Hot
- Applicable connector: Cannon XLR-3-31 or equivalent

NOTE: Do not short-circuit the hot or cold pin with the common pin.

41 BALANCED OUT (SELECTED/TUNER) connectors

- These are active balanced outputs using XLR type connectors. The signal selected with the OUTPUT SELECT switch and the headphones/display select button is output from these connectors.
- Pin layout: 1. Common
2. Cold
3. Hot
- Applicable connector: Cannon XLR-3-31 or equivalent

NOTE: Do not short-circuit the hot or cold pin with the common pin.

42 UNBALANCED OUT (CD) terminals

- These are unbalanced outputs using RCA type terminals. The CD's playback signals are output from these terminals.

43 UNBALANCED OUT (SELECTED/TUNER) terminals

- These are unbalanced outputs using RCA type terminals. The signal selected with the OUTPUT SELECT switch and the headphones/display select button is output from these terminals.

44 REMOTE Jack

- This is a stereo mini jack for wired remote control. For remote circuit connections, refer to page 14.

DISPLAY

- RDS (Radio Data System) When the SEARCH/CHA button is pressed, a station is searched for and automatically tuned in, the "RDS" indicator lights and the station's name is displayed on the frequency display.
- PTY (Program Type) This indicator lights when the type of RDS program is specified.
- TP (Traffic Program) "TP" lights when an RDS traffic information station is received.
- PS (Program Service name) This lights when the station name is displayed.

The selected functions, volume, reception band, reception frequency, RDS data, time, and timer settings are displayed here.

The currently selected disc number is displayed in the disc number display in the CD mode.

The following is displayed in the track number display in the CD mode:

- When the disc's data cannot be read properly00
- In the stop modeTotal number of tracks
- In the play and programme modesTrack number

The following is displayed in the time display in the CD mode:

- When the disc's data cannot be read00:00
- In the stop modeTotal playing time
- In the play and pause modes.....Elapsed time for current track

These display the reception mode.

ST: This lights when a stereo program is received in the AUTO mode.

MONO: This lights when a monaural program is received in the AUTO mode and when the AUTO/MANU button is pressed, setting the manual mode.

AUTO: This lights when the AUTO/MANU button is pressed, setting the auto mode.

This lights when a station is tuned in properly.

"P.SET" lights when the tuner preset number is displayed.

This flashes for approximately 10 seconds when the MEMORY button is pressed while presetting stations.

▶ (the play indicator) lights when a disc is playing, and || (the pause indicator) lights when the pause mode is set.

"RANDOM" lights during the random play.

"PROG" lights during programmed playback.

This changes as follows each time the REPEAT button is pressed:

- 1st press: RPT 1 (single-track repeat) is displayed.
- 2nd press: RPT DISC (1 disc all track repeat) is displayed.
- 3rd press: RPT ALL DISC (all disc all track repeat) is displayed.
- 4th press: Nothing is displayed.

Flashes when remote control signals are received.

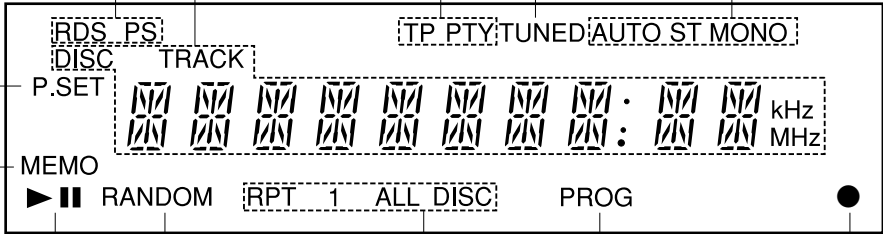

OPENING AND CLOSING THE DRAWER AND LOADING A DISC

Opening and closing the drawer (This operation only works while the power is on.)

1. Press the POWER switch to turn on the power.
2. Press the OPEN/CLOSE button (▲).

How to load a disc

- Make sure the drawer is completely open.
- Hold the disc by the edges and place it on the disc tray. (Do not touch the signal surface, i.e., the glossy side.)
- Set the disc properly in the tray according to its size. Set 8cm discs in the center hole. Set 12cm discs in the outer hole.
- When the drawer is opened during the stop mode, discs can be loaded in the disc 1 to disc 4 trays. If the DISC SKIP button is pressed, the carousel turns and a disc can be loaded in the disc 5 tray. When the drawer is opened during the play mode, it is possible to load and unload discs in all of the disc trays other than the one whose disc is currently playing. In this case, the DISC SKIP button will not operate.
- Press the OPEN/CLOSE button (▲) to close the drawer.

Caution:

- The player will not operate properly and the disc may even be damaged if it is not set correctly.
- If your finger should get caught in the drawer when it closes, press the OPEN/CLOSE button (▲).
- Do not place any foreign objects on the disc tray, and do not place more than one disc on the tray at a time. Otherwise malfunction may occur.
- Do not push in the drawer manually when the power is off as this may cause malfunction and damage the TUNER-5CD CHANGER.
- Do not touch the carousel while it is turning. Also, do not turn the carousel by hand when it is stopped. Doing so could damage it.
- Do not insert disc where indicated by arrow. This could damage the internal mechanism in the unit.

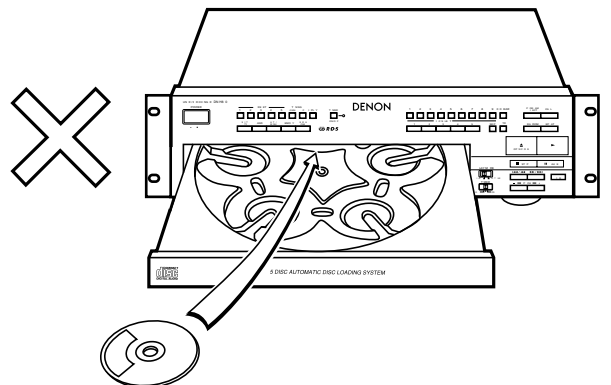
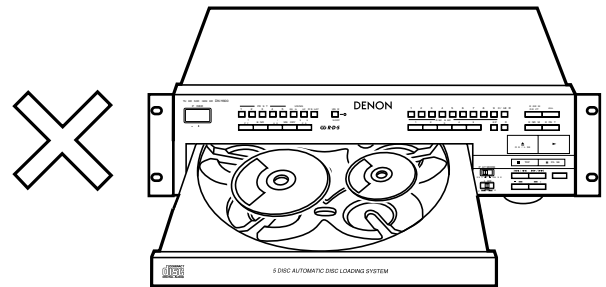
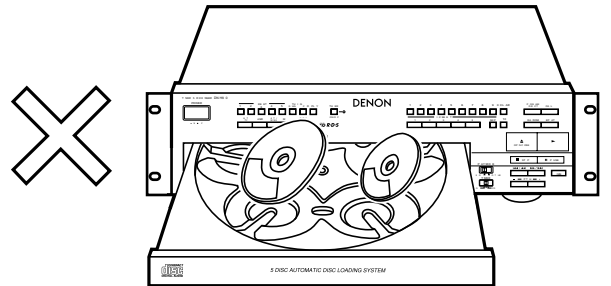
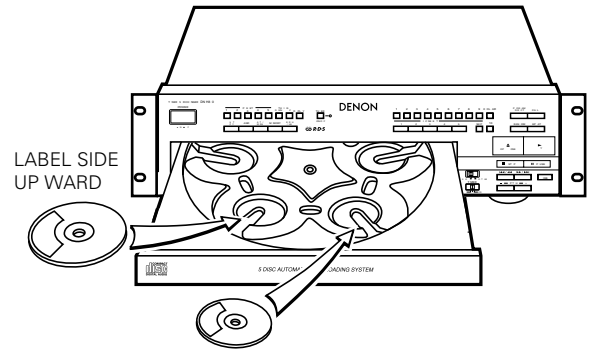

CONNECTIONS

■ Connecting the included antennas

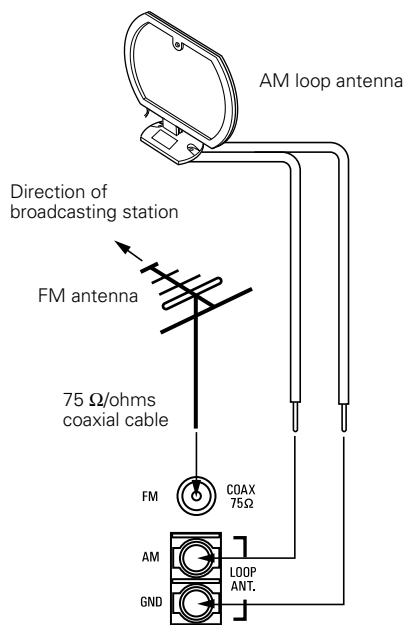

Connecting an FM outdoor antenna

If good reception cannot be achieved with the included FM antenna, use an FM outdoor antenna. Connect an F-shaped connector to the coaxial cable and connect the antenna to the FM COAX (75 Ω/ohms) terminal.

Selecting a place for the FM outdoor antenna

- Set the antenna so that it is pointing towards the broadcast station's transmitting antenna. Behind buildings or mountains, set the antenna in the position at which reception is best, and also try changing the direction of the antenna.
- Do not install the antenna under power lines. Doing so is extremely dangerous, as the power line could touch the antenna.
- Install the antenna away from roads or train tracks to avoid noise from cars or trains.
- Do not install the antenna too high, as it may be hit by lightning.

Note to CATV system installer:

This reminder is provided to call the CATV system installer's attention to Article 820-40 of the NEC, which provides guidelines for proper grounding and, in particular, specifies that the cable ground shall be connected to the grounding system of the building, as close to the point of cable entry as practical.

Installing the AM loop antenna

Tune in an AM station and set the antenna in a position as far from the system as possible in which distortion and noise is minimum. In some cases it is best to invert the polarities. AM broadcasts cannot be received well if the loop antenna is not connected or if it is set close to metal objects.

* Place the antenna 10 cm away from the set.

Assembling the AM loop antenna

Assemble the included AM loop antenna as shown in the diagram.

- ① Remove the clamp.
- ② Insert the AM loop antenna into the antenna stand.

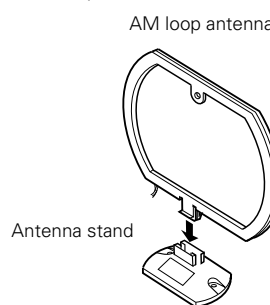

Connecting the AM loop antenna

Connect the included AM loop antenna to the antenna terminals as shown in the diagram.

- ① Loosen the terminal knobs.
- ② Insert the antenna wire.
- ③ Tighten the terminal knobs.

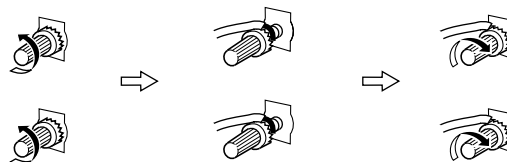

Installing an AM outdoor antenna

Connect the signal wire from the AM outdoor antenna to the antenna terminal. Be sure to ground the antenna and connect the ground wire to the GND terminal. Also be sure to connect the included AM loop antenna.

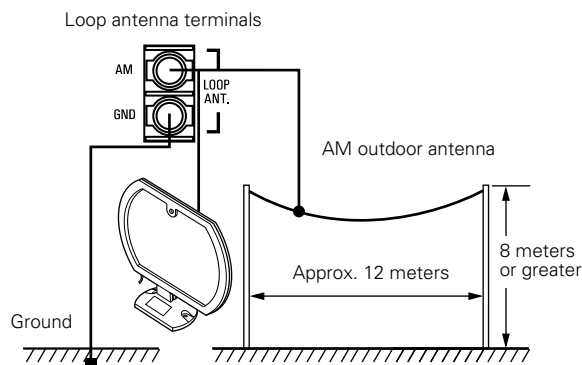

Leave your entire system (including the DN-H800) turned off until all connections between the DN-H800 and other components have been completed.

■ Connecting the DN-H800 to an Amplifier

- Before connecting the DN-H800 to your amplifier, it is a good practice to review your amplifier's instruction manual.
- Use the white plugs for the left channel and red plugs for the right channel.

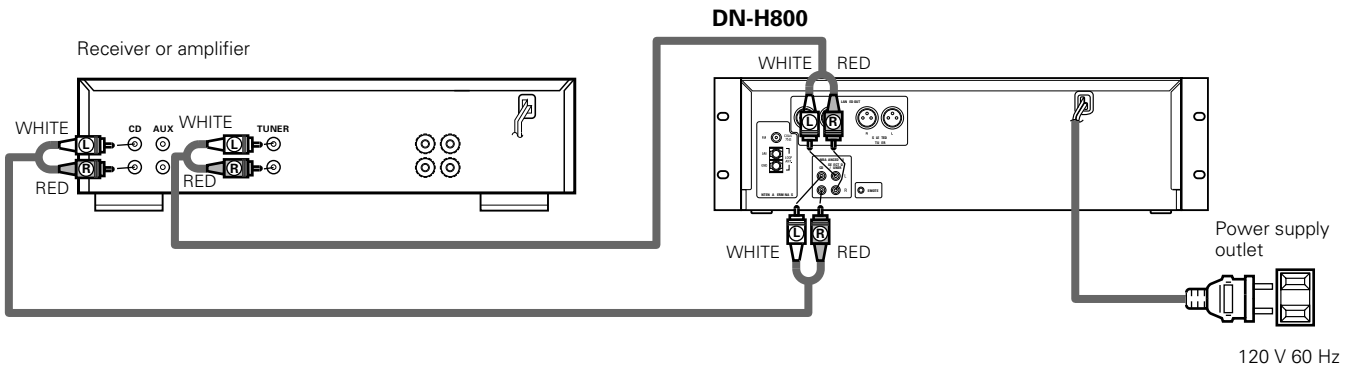

■ Connection Precautions

- Before proceeding with connections or disconnections of cables and power cords, be sure to turn all system components off.
- Ensure that all cables are connected properly to the L (left) and R (right) jacks.
- Insert plugs fully into the terminals.
- Connect the CD output jacks to the amplifier CD or AUX input jacks.

■ Wired remote control connections

- For wired remote control, use the circuit shown on the diagram below.
- Design the circuit so that the wire resistance is 0.5 Ω/ohms or less.

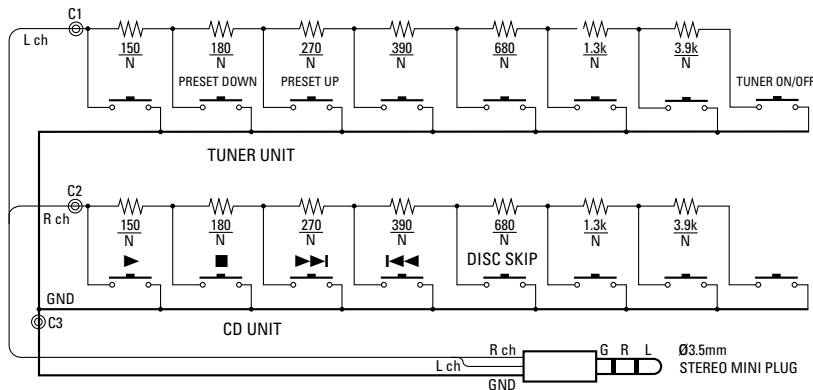

* $1 \leq N \leq 6$
 ("N" is the number of DN-H800 units connected.)

- Up to six units can be controlled simultaneously with one remote control unit.
- Wire the signal and ground lines as shown on the diagram below and connect at the remote control inputs (C1, C2 and C3).
- Design the circuit so that the resistance of the individual wires is 0.5 Ω/ohms or less.

Connecting two DN-H800 units (N = 2)

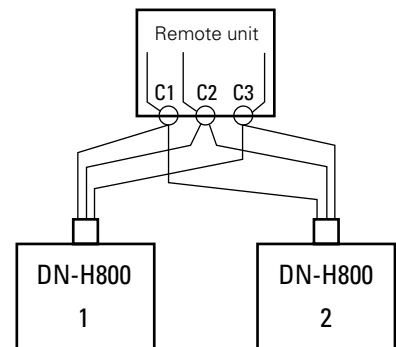

■ Installation Precautions

- If the DN-H800 is placed near amplifier, tuner or other components, noise (induced hum) or beat interference may result (especially during AM or FM reception).
 If this occurs, separate the DN-H800 from other components or reorient its position.

NOTE:

Use this unit in a horizontal orientation.

When the unit is used with the front panel facing upward (and the unit is in a vertical orientation) or when the front panel is on an incline, the will not operate properly.

NORMAL PLAY

Follow the steps below to get an understanding of the disc play procedure.

(1) Starting Playback

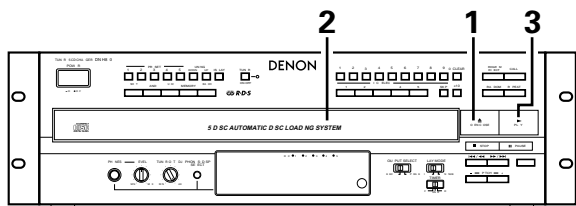

1. Turn the power switch on and press the OPEN/CLOSE (▲) button to open the drawer.
 2. Set the disc to be played in the tray on left side.
 3. Press the PLAY button (▶).
 4. The drawer close and the disc just loaded is played.
 5. The disc number, track number and elapsed time, etc., for the disc currently playing appear on the display window.
 6. If the OPEN/CLOSE (▲) button is pressed while a disc is playing, playback continues, but the drawer opens and four discs can be replaced.
- Press the OPEN/CLOSE (▲) button again to close the drawer.

(2) Stopping Playback

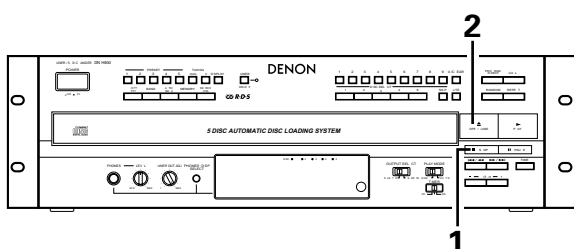

1. Press the STOP button (■) to stop playback.
2. To replace discs, press the OPEN/CLOSE (▲) button.
The disc which was playing switches over to the left side and the drawer opens.

- Set the disc you want to played in the left side.

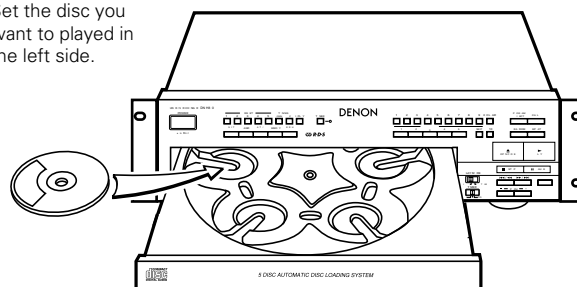

OTHER PLAY METHODS

In addition to normal play, the following methods can be used when playing a disc.

① To Play the Desired Disc and Desired Track Direct Selection

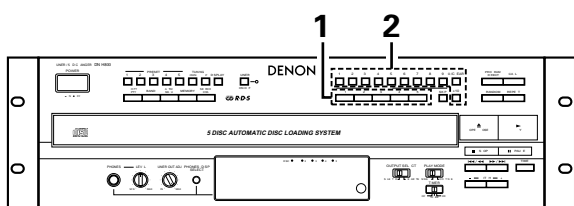

1. Use the DISC SELECT buttons (1 to 5) to select the number of the disc to be played.
 2. Next, use the number buttons (1 to 9, 0/CLEAR and +10) to select the number of the track to be played.
- For example, to play the 4th track on the 3rd disc:
Press [3] (DISC SELECT button) and [4] (number button).
To play the 12th track on the 5th disc:
Press [5] (DISC SELECT button), [+10] and [2] (number button).
Playback begins from the number of the disc and track selected.

② To Move to the Next Disc During Playback Disc Skip

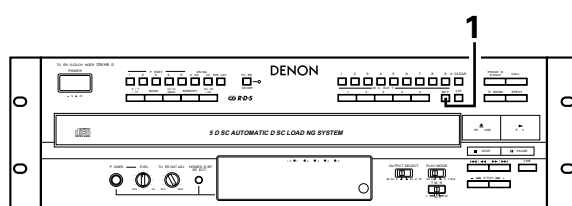

1. Press the SKIP button. The carousel in the drawer turns and the disc on the next tray is played.
For example, if disc number 3 was playing, the disc switches to disc number 4, and if disc number 5 was playing, the disc switches to disc number 1.

3 To Move to the Next Track during Play Automatic Search

Press the Automatic/Manual search forward button (▶▶/▶▶) for less than 0.5 seconds during playback.

- The pickup will advance to the beginning of the next track and playback will continue. Pressing the button several times will forward the pickup the corresponding number tracks.

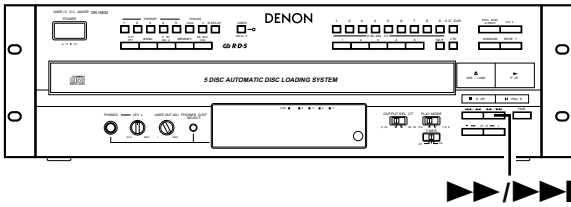

Press the ▶▶/▶▶ button.

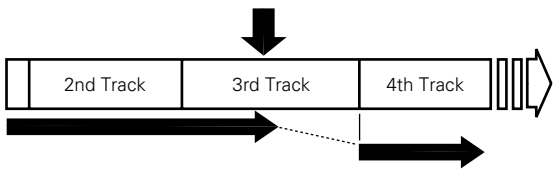

- During Random or Program operation, player moves to the beginning of the next random or program track selection.

4 To return to the beginning of the track now being played Automatic Search

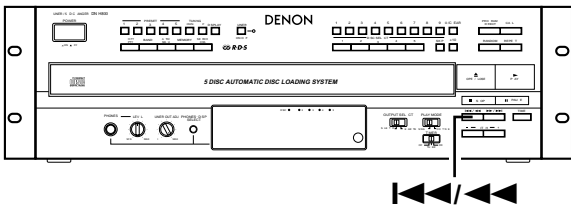

Press the Automatic/Manual search reverse button (◀◀/◀◀) for less than 0.5 seconds during playback.

- The pickup will return to the beginning of the current track and playback will continue. Pressing the button several times will return the pickup the corresponding number tracks.

Press the ◀◀/◀◀ button.

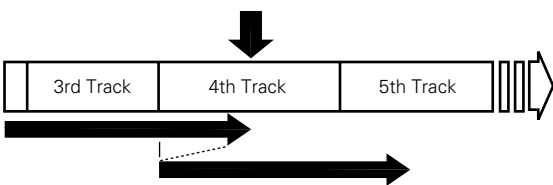

5 To Play the Desired Discs and the Desired Tracks in the Desired Order Program Selection

- You can play certain tracks on the loaded discs in any order.
- Tracks on a disc not loaded can also be programmed, but if you try to play that disc, the microprocessor detects that it is not loaded and the following disc is played automatically.
- Up to 20 tracks can be set in program.
- A program can be made for a single entire disc.

(1) Programming

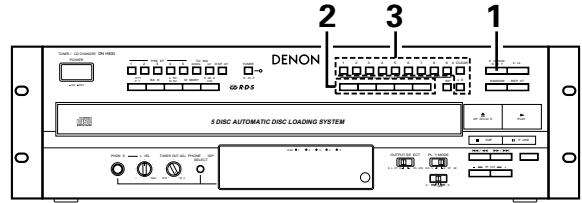

- Press the PROGRAM/DIRECT button. The "PROG" and "PP" indicator lights. Use the DISC SELECT button, number buttons to select the disc to be programmed.

For example, to program the 3rd track on the 2nd disc and the 12 track on the 5th disc, press [PROGRAM/DIRECT], [2] (DISC SELECT button), [3] (number button), [5] (DISC SELECT button), [+10] and [2] (number button).

If all the tracks are being selected from the same disc, all the tracks on a particular disc can be played, such as from the 1st track of the 3rd disc, all tracks of the 5th disc and the 5th track of the 5th disc. In the case, press [PROGRAM/DIRECT], [3] (DISC SELECT button), [1] (number button), [5] (DISC SELECT button), [5] (DISC SELECT button) and [5] (number button).

(2) To Check the Programmed Tracks

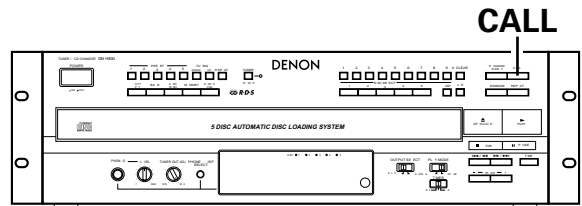

- Press the CALL button. The contents of the program are displayed in order one item at a time each time the CALL button is pressed.
- When the 0/CLEAR button is pressed, the displayed track number is cleared.

(3) To Play a Program

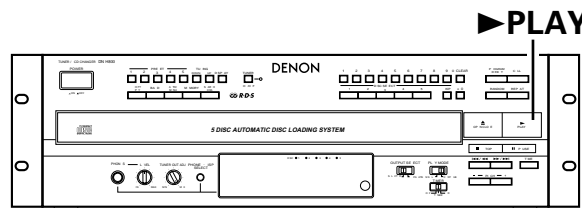

- Press the PLAY (▶) button to play the programmed selections in the order in which they were programmed.

(4) To clear the entire program

- Pressing the PROGRAM/DIRECT button once more erases the entire program. Pressing the OPEN/CLOSE (▲) button also erases the contents of a program.
- Pressing the PROGRAM/DIRECT button while a program is being played cancels the program. Play will then be continuous to the end of the disc currently being played, after which the player will stop automatically.

Cautions

- If a program is run during playing of a track or from the Pause state, the track which is currently being played becomes the 1st track in the program.
- Additional tracks can be added to the program, but the player will not display the number of tracks in the program or the playing time.
- Direct selection cannot be done while a program is being played. Inputting the track number of a desired track with the Track Number buttons adds the input track to the end of the program.
- When programming, do not program a track number which is not recorded on the disc. If such a number is programmed by mistake, the player ignore the program.

6 To Repeat Play Repeat Play

- Switch the PLAY MODE switch to CONTINUE, then press the REPEAT button. The "RPT" indicator will light up. (The repeat play mode cannot be set when the PLAY MODE switch is set to SINGLE.)

* Steps 1 and 2 can be done in any order, with the same results.

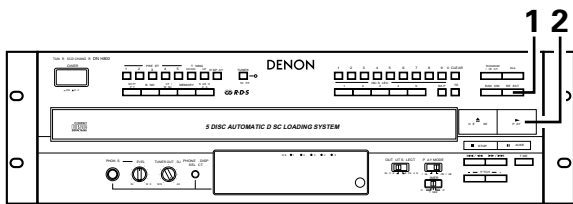

- When the REPEAT button is pressed once, the "RPT" and "1" indicators light. In this mode, the track currently playing is repeated.

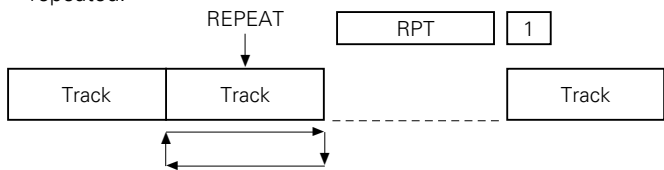

- If the REPEAT button is pressed again, the "RPT" and "DISC" indicators light, and the disc currently playing is repeated.

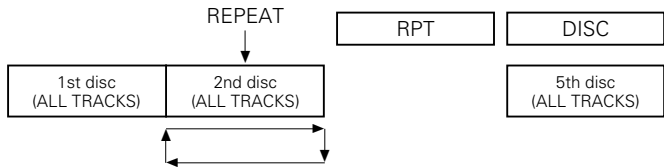

- If the REPEAT button is pressed again, the "RPT" and "ALL DISC" indicators light, and all the discs currently loaded are repeated.

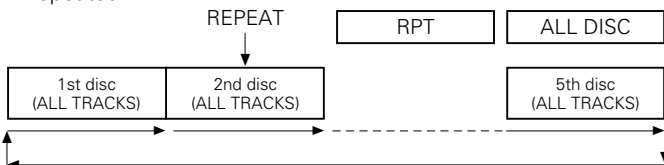

- Pressing the REPEAT button during play will also cause the player to repeat play.
- To cancel repeat play, press the REPEAT button once more.
- Pressing the REPEAT button while a program is being played will cause the tracks in the program to be played again in order.
- Pressing the REPEAT button during Random play will cause the tracks to be played again at random.

NOTE:

Initially the number of repeats is unrestricted. The number of repeats can be restricted as shown below by pressing the TIME and REPEAT buttons simultaneously while in the stop mode.

- 1 TRACK REPEAT, 1 DISC REPEAT and PROGRAM REPEAT5 times
- ALL DISC REPEAT and RANDOM REPEAT3 times

7 Letting the Player Select the Order of Play Random Play

(1) Full Random Play

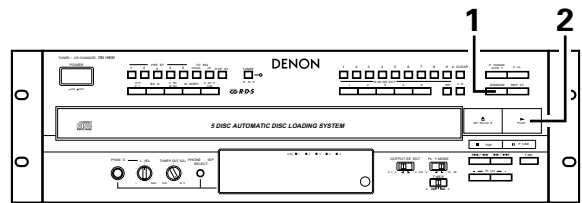

- Press the RANDOM button, then press the PLAY (▶) button. The microcomputer will then start play of the tracks on the 5th disc at random.

(2) Program Random Play

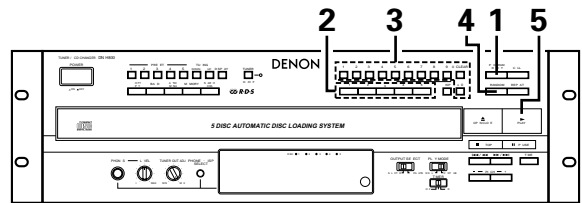

- After pressing the PROGRAM/DIRECT button and inputting a program (Refer to page 16, item 5), press the RANDOM button, then the PLAY (▶) button. The microcomputer will then select tracks from the program at random and play them.

(3) Disc Sequential Random Play

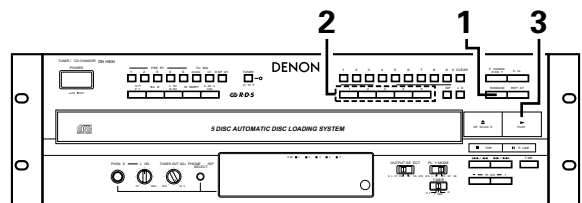

- Press the RANDOM button and specify the disc numbers (1 to 5) with the DISC SELECT buttons. A press of the PLAY (▶) button will result in the player randomly selecting and playing tracks on the disc in the order of specified discs.

(4) To Cancel Random Play

- Pressing the RANDOM button once more cancels the Random function. Play will then proceed from the track currently being played to the end of the last track on the disc, then stop. Pressing the OPEN/CLOSE (▲) button also cancels the Random function.

Cautions

- Pressing the RANDOM button during normal play starts full random play.
- Pressing the RANDOM button during Program play starts random play of the tracks in the program, including the tracks which have already been played.
- During random play, the player may display the number of disc which is not loaded in the tray. In such a case, the player will read the disc information, then reset automatically to correct. This is not a malfunction.

8 To Stop Play Temporarily Pause

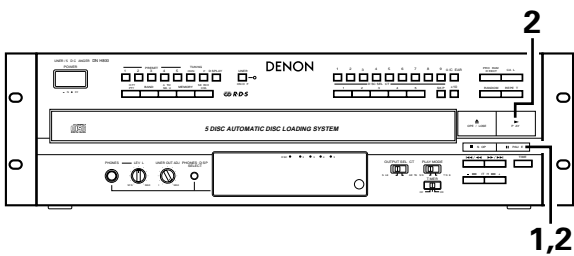

- Pressing the PAUSE button during play stops play at that point. Pressing the PAUSE button once more starts play again from the same point.
1. Press the PAUSE (||) button.

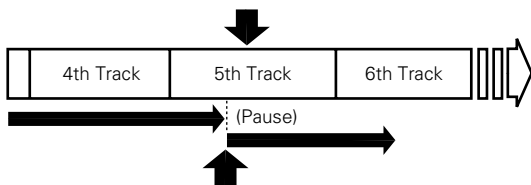

2. Press the PLAY (▶) button or the PAUSE (||) button.
- * Press the PLAY (▶) button or the PAUSE (||) button to start play.

9 Audible quick search Manual Search

- Using this function, you can cue to a desired point within a track, either in the forward or reverse direction.
- Release the automatic/manual search button (⏮/⏪ or ⏩/⏭) when the desired point has been reached. Normal playback then continues.

(1) Manual Search Forward

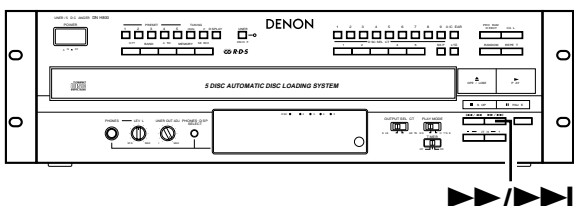

1. Keep on pressing the automatic/manual search forward button (⏩/⏭) for more than 0.5 seconds during playback. Playback of the track is speed up.
- As a reference, the current track number and elapsed playback time within the track are displayed.
- Manual search forward is approximately three times faster when engaged during the pause state compared to playback. In this case, no sound is heard however.
- If the automatic/manual search forward button (⏩/⏭) is held in until the end of the disc is reached, the next disc is selected.

(2) Manual Search in Reverse

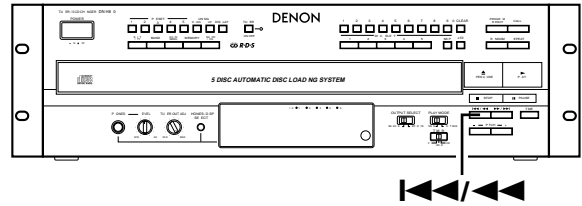

1. Keep on pressing the automatic/manual search reverse button (⏮/⏪) for more than 0.5 seconds during playback. Reverse playback of the track is sped up.
- As a reference, the current track number and elapsed playback time within the track are displayed.
- Manual search in reverse is approximately three times faster when engaged during the pause state compared to playback. In this case, no sound is heard however.
- If the automatic/manual search reverse button (⏮/⏪) is pressed continuously, it will reach the beginning of the first track on the disc. Release the automatic/manual search reverse button (⏮/⏪) to resume normal playback.

10 To Cue and Stop Play Pause

(1) Cuing by Direct Selection

- Cuing by direct selection, then entering the Pause state, is convenient for practicing vocals with background music.

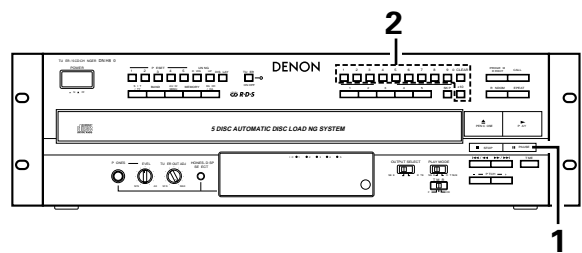

1. Press the PAUSE (||) button.
 2. Press the number buttons to set the number of the desired track.
- To start play, press the PLAY (▶) button or the PAUSE (||) button.

(2) Cuing by Program Selection

- After setting the desired track selections in a program, press the PAUSE (||) button. The player will advance to the beginning of the 1st track in program memory and wait in the Pause state.

11 Playing at a different pitch PITCH

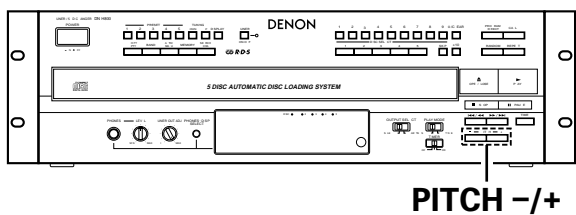

1. Press the PITCH + and – button. Playback begins at the set pitch.

NOTE:

The playing pitch can also be changed using the PITCH + and – buttons. When this is done, the pitch display flashes. If the pitch is changed on the main unit, playback is performed at the pitch which was last set.

INSTALLATION PRECAUTIONS

The CD player uses a microcomputer for controlling internal electronic circuits. In the event that the player is used while a near-by tuner or TV is turned on, although unlikely, interference could occur either in the sound from the tuner or the picture of the TV. To avoid this, please take the following precautions.

- Keep the CD player as far away from the tuner or TV set as possible.
- Keep the power cable and connecting cable of the CD player separate from the antenna wires of the tuner and TV.
- Interference is particular likely to occur when an indoor antenna or a 300 Ω/ohms feeder cable is used. Thus, use of an outdoor antenna and 75 Ω/ohms coaxial cable is strongly recommended.

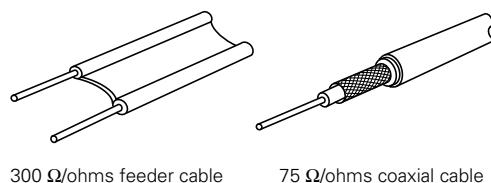

300 Ω/ohms feeder cable

75 Ω/ohms coaxial cable

COMPACT DISCS

1. Cautions in Handling Compact Discs

- Do not get fingerprints, oil, dirt or other substances on the compact disc. If the disc becomes dirty, wipe it off with a dry, soft cloth.
- Do not clean compact discs with benzene, paint thinner, water, record spray, anti-static agent, silicon cloth or similar substances.
- Take particular care to prevent scratches to the back side of the compact disc when removing it from the case and when inserting it in its case.
- Do not bend compact discs.
- Do not apply to compact discs.
- Do not attempt to enlarge the center hole of the disc.
- Do not write on the label (printed) side of the disc with a ball point pen or pencil.
- Bringing a CD into a warm room from a cold place could cause moisture to condense on the disc surface. Do not attempt to dry the disc with a hair dryer, etc.

2. Storage of Compact Discs

- After play, be sure to remove the disc from the player.
- To prevent dust, scratches, deformation, etc., be sure to store compact discs in their case.
- Do not store compact discs in the following locations.
 1. Places where direct sunlight strikes for long periods of time.
 2. Places with a high humidity or a lot of dust.
 3. Places reached by heat from a heater or similar appliance.

LISTENING TO RADIO PROGRAMS

Using the Various Functions

1. Using the auto preset memory function

This function automatically stores the FM stations which can be received in the area in which the set is being used in the preset memory. Use this function so that the RDS functions can be used more effectively. Also note that the channel memories can be changed at will even after the preset stations have been stored with this function.

Operation

1. Connect the FM antenna and set it so that FM stations can be received.
2. Press the POWER button to turn on the power while holding in the MEMORY and SHIFT/PTY button.
3. Searching begins automatically and stations are stored in the preset memory in order, beginning from channel A1. (The operation automatically stops once 30 stations have been set in the memory).

2. Storing new stations at the preset channels

The reception frequency, RDS service information. Tuning mode and input characters can be stored at the different channel memories.

When this operation is performed, the station already stored in that channel memory using the auto preset memory function is cleared.

Operation

1. Press the MEMORY button. (The "MEMO" indicator flash.)
2. Use the SHIFT/PTY button to select the block, A to F.
3. Use PRESET buttons (1 to 5) to select the channel at which the station is to be stored.
4. Press the MEMORY button while the "MEMO" indicator is flashing.

3. Recalling preset channels

Use the following operation to recall preset channels:

Operation

1. Use the SHIFT/PTY button to select the block, A to F.
2. Use PRESET buttons (1 to 5) to select the channel at which to store the station.

4. Inputting characters

Some characters can be input (up to 8 characters). The input characters can be stored at the preset channels.

Operation

1. Press the SEARCH/CHA button four times. (The cursor flashes at the first place.)

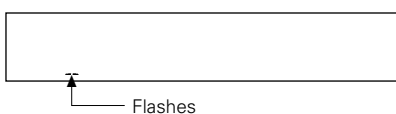

2. Use the TUNING buttons to select the character for the first place. (The selected character flashes.)

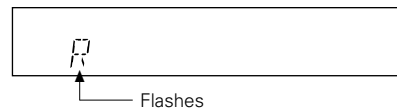

3. Press the SHIFT/PTY button to move the cursor the next place. (The cursor flashes at the second place.)

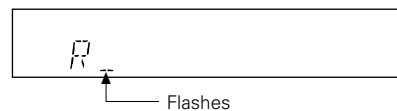

4. Repeat steps 2 and 3 above to input up to 8 characters.

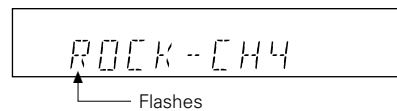

5. Press the MEMORY button twice within 5 seconds of entry completion. The input characters can be stored in the memory.

To keep the input characters, be sure to store them in a channel memory.

6. Clearing characters

1. Recall the character you want to clear.
2. Press the SEARCH/CHA button 4 times until the character at the first place flashes.
3. Then press the SHIFT/PTY button for at least 4 seconds. The current character will then be cleared.

Using the RDS Functions (for FM only)

1. RDS Search

Use this to automatically search and stop at station offering RDS services.

Operation

1. Press the SEARCH/CHA button once.

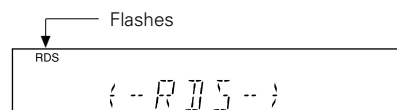

2. Press the TUNING button to start a search of the preset frequencies.

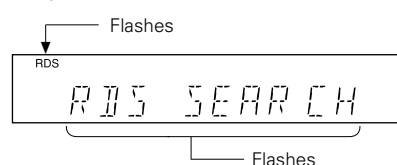

3. Press the TUNING button while the RDS indicator is flashing to start a search of all frequencies.

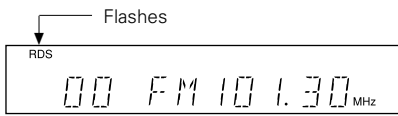

4. If no other RDS station is found when all the frequencies are searched, "NO PROG" is displayed.

2. PTY search

Use this to automatically search and stop at stations broadcasting the specified programme type (PTY).

Operation

1. Press the SEARCH/CHA button twice.

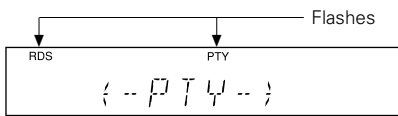

2. Use the SHIFT/PTY button to select the programme type.

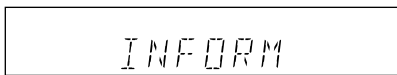

3. Press the TUNING button to start a search of the preset frequencies.

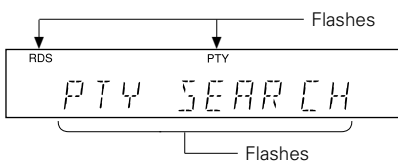

4. Press the TUNING button while the PTY indicator is flashing to start a search of all frequencies.

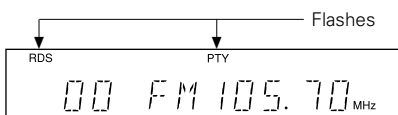

5. If no other station broadcasting the designated programme type is found when all the frequencies are searched, "NO PROG" is displayed.

List of PTY (Programe Type) Displays

- | | |
|----------------------------|--------------------------------|
| 1. NEWS | 12. SOFT |
| 2. INFORM (Information) | 13. NOSTALGA (Nostalgia) |
| 3. SPORTS | 14. JAZZ |
| 4. TALK | 15. CLASSICL (Classical) |
| 5. ROCK | 16. R+B (R&B) |
| 6. CLS ROCK (Classic Rock) | 17. SOFT R+B (Soft R&B) |
| 7. ADLT HIT (Adult Hits) | 18. LANGUAGE |
| 8. SOFT RCK (Soft Rock) | 19. REL MUSC (Religious Music) |
| 9. TOP 40 | 20. REL TALK (Religious Talk) |
| 10. COUNTRY | 21. PERSNLTY (Personality) |
| 11. OLDIES | 22. PUBLIC |

3. TP Search

Use this to automatically search and stop at stations which broadcast traffic announcements (even if the station is not currently broadcasting a traffic announcement).

Operation

1. Press the SEARCH/CHA button three times.

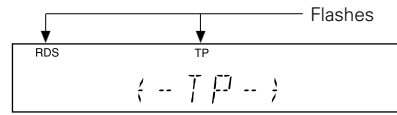

2. Press the TUNING button to start a search of the preset frequencies.

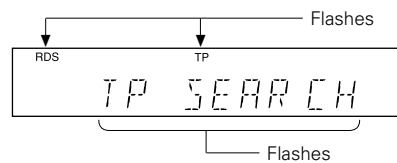

3. Press the TUNING button while the TP indicator is flashing to start a search of all frequencies.

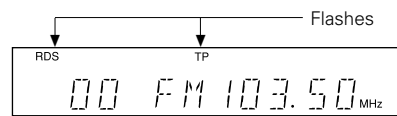

4. If no other TP station is found when all the frequencies are searched, "NO PROG" is displayed.

USING THE TIMER

- Timer recording/playback can be made using any audio timer available on the market.

■ Playing a compact disc with the timer

1. Make sure the connections are correct, especially the power supply connections.
2. Turn "ON" the POWER switch of each appliance.
3. Load the disc to be played back.
4. Set the monitor switch of the Amplifier to the CD position.
5. Press the PLAY (▶) button and playback the CD; adjust the playback level.
Press the STOP (■) button.
6. Set the TIMER switch to the "CD" side.

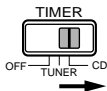

7. Set the audio timer to the desired time. The audio timer will turn the power supply on the desired time.

■ Play the tuner with the timer

1. Make sure the connections are correct, especially the power supply connections.
2. Turn "ON" the POWER switch of each appliance.
3. Use the PRESET buttons to set the preset channel number.
4. Set the TIMER switch to the "TUNER" side.

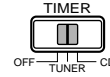

5. Set the audio timer to the desired time. The audio timer will turn the power supply on at the desired time.

* With the above procedures, timer playback can be accomplished. When the preset time comes, the power is supplied and playback will start.

Timer playback is performed as described below, depending on the CD play mode set before timer playback starts.

Direct mode: Playback starts from the first track on the disc that was played last.

Program mode: Playback starts from the first track in the program.

Random mode: Playback starts in the random mode.

REMOTE CONTROL UNIT RC-176

This is a separately sold remote control unit.

(The separately sold remote control unit is not included with the DN-H800.)

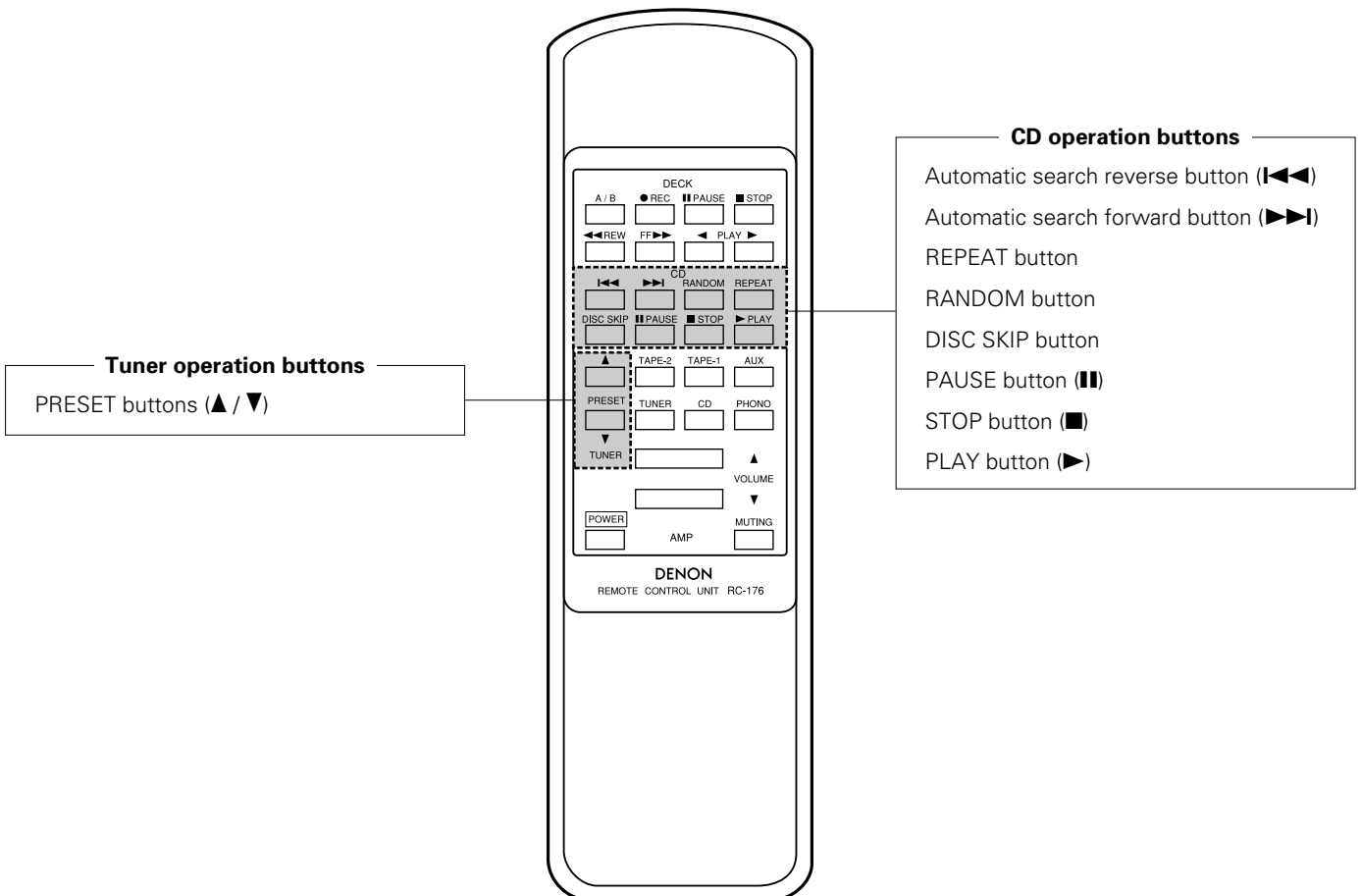

TROUBLESHOOTING

Check the following once more before assuming there is a problem with the system.

1. Are connections proper ?

2. Is the system being operated as explained in the operating instructions ?

If the system does not seem to be operating properly, check as shown on the table below. If none of these checks apply to the problem, the system may be malfunctioning. Disconnect the power cord immediately and contact your store of purchase.

	Symptom	Cause	Countermeasure	Page
General	Power does not turn on when power operation switch is pressed.	<ul style="list-style-type: none"> Power cord is not plugged into a power outlet. 	<ul style="list-style-type: none"> Plug the power cord securely into an outlet. 	14
Tuner section	Hissing sound is heard in FM broadcasts.	<ul style="list-style-type: none"> Antenna direction is poor. Signals from the broadcast station are weak. 	<ul style="list-style-type: none"> Change the direction of the antenna. Install an outdoor antenna. 	13 13
	Hissing sound is heard in AM broadcasts.	<ul style="list-style-type: none"> Noise from a TV or interference from a broadcast station. 	<ul style="list-style-type: none"> Turn the TV off. Change the direction of the loop antenna. Install an outdoor antenna. 	– – 13
	Humming sound is heard in AM broadcasts.	<ul style="list-style-type: none"> Signals on the power cord are being modulated by the power source frequency. 	<ul style="list-style-type: none"> Insert the power cord in the opposite direction. Install an outdoor antenna. 	– 13
CD player section	Total number of tracks not displayed when disc is loaded.	<ul style="list-style-type: none"> Disc is loaded upside-down. Disc is dirty. Disc is not of the specified type. 	<ul style="list-style-type: none"> Reload the disc. Clean the disc. Replace with a disc of the specified type. 	12 19 –
	Nothing happens when operating buttons are pressed. Disc stops in the middle of a track and will not play properly.	<ul style="list-style-type: none"> Disc is loaded upside-down. Foreign object on disc tray. Disc is dirty. Disc is scratched. 	<ul style="list-style-type: none"> Reload the disc. Remove the disc and the foreign object. Clean the disc. Replace with an unscratched disc. 	12 – 19 –
	Sound is broken.	<ul style="list-style-type: none"> Dirt, fingerprints, spittle, etc, on disc. Disc is scratched. Player is in an unstable place and vibrated strongly. 	<ul style="list-style-type: none"> Clean the disc. Replace with an unscratched disc. Place the player in a stable place with no vibrations. 	19 – –
	Humming sound is heard, when disc is played.	<ul style="list-style-type: none"> Signals on the power cord are being modulated by the power source frequency. 	<ul style="list-style-type: none"> Insert the power cord in the opposite direction. 	–

SPECIFICATIONS

CD SECTION

Audio Channel:	2 channel stereo
Frequency Response:	20 ~ 20,000 Hz (± 1.0 dB)
High Frequency Distortion:	0.02 % (1 kHz)
Signal-to-noise Ratio:	94 dB
Channel Separation:	85 dB
Output:	RCA jack
Output Level:	2.0 V
Variable Pitch Control:	± 12 % max.
Discs:	Audio compact discs are used 12 cm (5 in) and 8 cm (3 in)

TUNER SECTION

Reception frequency band:	FM: 87.5 MHz ~ 108.0 MHz AM: 520 kHz ~ 1710 kHz
Reception sensitivity:	FM: 1.5 μ V/75 Ω /ohms AM: 20 μ V
FM stereo separation:	35 dB (1 kHz)

REMOTE

Wired Remote Control Connection (Stereo mini jack)
Remote Control Sensor

GENERAL

Headphone Output:	Stereo (CD, TUNER)
Outputs Line:	20 mW or more
Load Impedance:	33 Ω /ohms or more
Power Supply:	120 V AC ± 10 %, 60 Hz
Power Consumption:	19 W
Installation:	19-inch rack mountable (3 U)
Weight:	7.6 kg

* Specification and design are subject to change without notice for purpose of improvement.